

CHAPTER 6

PO 306 – FIRE THE CADET AIR RIFLE DURING RECREATIONAL MARKSMANSHIP



COMMON TRAINING
SILVER STAR
INSTRUCTIONAL GUIDE



SECTION 1

EO M306.01 – PARTICIPATE IN A RECREATIONAL MARKSMANSHIP ACTIVITY

Total Time:

90 min

PREPARATION

PRE-LESSON INSTRUCTIONS

Resources needed for the delivery of this lesson are listed in the lesson specification located in A-CR-CCP-703/PG-001, Chapter 4. Specific uses for said resources are identified throughout the instructional guide within the TP for which they are required.

Review the lesson content, unit range standing orders, and become familiar with the material prior to delivering the lesson.

Photocopy the targets located at Annexes B to J as required.

Construct a range IAW A-CR-CCP-177/PT-001, *Canadian Cadet Movement: Cadet Marksmanship Program Reference Manual*.

PRE-LESSON ASSIGNMENT

N/A.

APPROACH

A practical activity was chosen for this lesson as it is an interactive way to allow the cadet to experience recreational marksmanship in a safe and controlled environment. This activity contributes to the development of marksmanship skills and knowledge in a fun and challenging setting.

INTRODUCTION

REVIEW

The review for this lesson will be from EO M106.02 (Carry Out Safety Precautions on the Cadet Air Rifle, A-CR-CCP-701/PF-001, Chapter 6, Section 2).

QUESTIONS

- Q1. Why do we follow safety regulations?
- Q2. How would you verify the safety catch is ON?
- Q3. What are the four “ACTS” of firearm safety?

ANTICIPATED ANSWERS

A1. We follow safety regulations to prevent accidents with the cadet air rifle.

A2. When the safety is ON, no red can be seen.

A3. The mnemonic "ACTS" stands for:

- Assume every firearm is loaded.
- Control the muzzle direction at all times.
- Trigger finger must be kept off the trigger and out of the trigger guard.
- See that the firearm is unloaded (prove it safe).

OBJECTIVES

By the end of this lesson the cadet shall have participated in a recreational marksmanship activity.

IMPORTANCE

It is important for cadets to participate in a recreational marksmanship activity because it allows them to experience marksmanship in a fun, dynamic and safe setting.

Teaching Point 1

Supervise the Participation of the Cadet in a Recreational Marksmanship Activity

Time: 80 min

Method: Practical Activity



A range briefing is conducted to pass on vital information and answer any questions the cadets may have prior to participating in a marksmanship activity. The range briefing is required to ensure the safe execution of a marksmanship activity.

CONDUCT A RANGE BRIEFING

1. Explain pertinent sections of the local range standing orders.
2. Review general rules observed on all ranges, to include:
 - (a) proving that rifles are safe prior to being picked up, handed to or received from another person;
 - (b) never pointing rifles at people;
 - (c) inserting safety rods into the barrels of rifles when not in use on the range;
 - (d) never horseplaying on a range;
 - (e) always pointing rifles down range; and
 - (f) following the Range Safety Officer's (RSO) directions and orders at all times.



Review range commands with an explanation and demonstration for each command.
All loading/firing is to be simulated.

3. Review commands used on an air rifle range (as illustrated in Figure 6-1-1).

| Command | Action to Be Taken |
|---|---|
| Cover Off Your Firing Point | Stand up, move behind the firing point and await further commands. |
| Place Your Equipment Down and Stand Back | Lay the equipment down on the mat and stand back when finished. |
| Adopt the Prone Position | Adopt the prone position, pick up the rifle, ready the equipment and put on hearing and eye protection. |
| Type of Firing (GRIT) | <p>GRIT is the acronym for:</p> <ol style="list-style-type: none"> 1. Group (relay), 2. Range (distance), 3. Indication (number of rounds), and 4. Type (grouping, scored). |
| Relay, Load | <ol style="list-style-type: none"> 1. Pick up and hold the rifle with the dominant hand. 2. Ensure the safety catch is in the “ON” position. 3. Pump the rifle, observing a three second pause. 4. Load a pellet (flat end forward). 5. Close the bolt. |
| Relay, Fire | <ol style="list-style-type: none"> 1. Place the safety catch in the “OFF” position. 2. Aim the rifle at the target. 3. Squeeze the trigger. 4. Open the bolt. 5. Repeat the following sequence for each shot: <ol style="list-style-type: none"> (a) Pump the rifle, observing a three second pause. (b) Load a pellet (flat end forward). (c) Close the bolt. (d) Aim the rifle at the target. (e) Squeeze the trigger. (f) Open the bolt. 6. Place the safety in the “ON” position. 7. Partially open the pump lever. 8. Lay down the rifle. |

Director Cadets 3, 2006, Ottawa, ON: Department of National Defence

Figure 6-1-1 Air Rifle Range Commands

4. Describe the layout of the air rifle range.
5. Review hand-washing procedures on completion of firing. This is important because each time a person handles pellets, a small trace of lead is left on their hands. To decrease the risk of lead poisoning, it is important that all persons wash their hands thoroughly after handling pellets.

ACTIVITY

OBJECTIVE

The objective of this activity is to provide the cadet the opportunity to participate in a recreational marksmanship activity.

RESOURCES

- Cadet air rifle (one per firing lane),
- Cadet air rifle sling (one per cadet),
- Air rifle pellets,
- Target frame,
- Suitable target,
- Shooting mat,
- Safety glasses/goggles, and
- Pen/pencil.



Additional resources required for specific marksmanship activities may be found in the annexes.

ACTIVITY LAYOUT

N/A.

ACTIVITY INSTRUCTIONS

1. Brief cadets on safety rules or any other guidelines pertaining to the activity.
2. Divide the cadets into relays according to the number of firing lanes.
3. Conduct a recreational marksmanship activity, choosing from the following categories:
 - (a) classification (see Annex A),
 - (b) fun activities (see Annexes B to E),
 - (c) timed activities (see Annexes F to H), or
 - (d) competitive team/individual activities (see Annexes I and J).



If EO C306.03 (Adopt the Standing Position With the Cadet Air Rifle, Section 4) has been taught prior to this marksmanship activity, this EO may be conducted in the standing position.

SAFETY

Range activities will be conducted IAW A-CR-CCP-177/PT-001.

END OF LESSON CONFIRMATION

The cadets' participation in the activity will serve as the confirmation of this lesson.

CONCLUSION

HOMEWORK/READING/PRACTICE

N/A.

METHOD OF EVALUATION

N/A.

CLOSING STATEMENT

Marksmanship is a fun and exciting activity that requires personal discipline and teamwork skills. This activity has also developed into highly competitive levels at the provincial, regional, and national levels.

INSTRUCTOR NOTES/REMARKS

Hand-washing stations must be available for cleanup after the activity is completed.

Cadets may fire in the standing position if they have previously received the training during EO C306.03 (Adopt the Standing Position With the Cadet Air Rifle, Section 4).

REFERENCES

- A0-027 A-CR-CCP-177/PT-001 Director Cadets 3. (2005). *Canadian Cadet Movement: Cadet Marksmanship Program Reference Manual*. Ottawa, ON: Department of National Defence.
- A0-041 Director Cadets 4. (2007). CATO 14-41, *Marksmanship, Rifles and Ammunition*. Ottawa ON: Department of National Defence.



COMMON TRAINING
SILVER STAR
INSTRUCTIONAL GUIDE



SECTION 2

EO C306.01 – IDENTIFY CIVILIAN MARKSMANSHIP ORGANIZATIONS

Total Time:

30 min

PREPARATION

PRE-LESSON INSTRUCTIONS

Resources needed for the delivery of this lesson are listed in the lesson specification located in A-CR-CPP-703/PG-001, Chapter 4. Specific uses for said resources are identified throughout the instructional guide within the TP for which they are required.

Review the lesson content and become familiar with the material prior to delivering the lesson.

Consult the Internet or local telephone directory to identify the national, provincial and local civilian marksmanship organizations applicable to the corps.

PRE-LESSON ASSIGNMENT

N/A.

APPROACH

An interactive lecture was chosen for this lesson to orient the cadet to opportunities available to enhance their marksmanship training with civilian organizations.

INTRODUCTION

REVIEW

N/A.

OBJECTIVES

By the end of this lesson the cadet shall have identified opportunities to enhance their marksmanship training with civilian organizations.

IMPORTANCE

It is important for the cadets to identify local civilian marksmanship organizations and understand that the activities available through these organizations are personal and not supported by the Cadet Program. Civilian marksmanship organizations assist people who are interested in marksmanship.

Teaching Point 1**Discuss Local Civilian Marksmanship Organizations**

Time: 5 min

Method: Interactive Lecture



Inform the cadets of a local civilian marksmanship organization and identify available activities and requirements for membership.

Civilian marksmanship organizations and rifle associations are popular throughout the world and are found in many countries. Traditionally formed to augment the military, marksmanship organizations now have become governing bodies for civilians interested in marksmanship.

Local civilian marksmanship organizations exist in most major cities in Canada. These organizations can include the city or regional rifle associations or local rod and gun clubs. These organizations usually have a small calibre rifle range available for their members' use. To find local civilian marksmanship organizations, refer to the Internet or the local telephone listings.

CONFIRMATION OF TEACHING POINT 1**QUESTIONS**

- Q1. Why were civilian marksmanship organizations traditionally formed?
 Q2. What are some examples of these organizations?
 Q3. How would you find some organizations in your area?

ANTICIPATED ANSWERS

- A1. They were traditionally formed to augment the military.
 A2. City or regional rifle associations or local rod and gun clubs.
 A3. Refer to the internet or local telephone listings.

Teaching Point 2**Discuss the Applicable Provincial Rifle Organizations**

Time: 10 min

Method: Interactive Lecture

PROVINCIAL RIFLE ORGANIZATIONS

Select the rifle association for the province in which the cadet corps is located.



Civilian marksmanship organizations assist people interested in marksmanship to advance their skills in marksmanship. These activities are not supported by the Cadet Program.

Provincial rifle associations are the provinces' governing bodies on fullbore and smallbore target shooting. These associations exist to promote marksmanship within the province by organizing events and competitions. Provincial rifle associations also provide competitions for cadet units within their province. Provincial associations include:

Alberta Provincial Rifle Association. The Alberta Provincial Rifle Association (APRA) was created in 1902, as the Territorial Rifle Association, before the Province of Alberta was created. The objectives of the APRA are:

- to promote in every lawful way the interests of small arms marksmanship in the Province of Alberta;
- to promote annual prize meetings for individuals and teams and to offer prizes for skill in shooting;
- to encourage the establishment and maintenance of suitable ranges through legislation and private means;
- to assist in the formation of shooting clubs; and
- to create public interest for the encouragement of small arms shooting both as a sport and as a necessary means of national defence;

The APRA can be found on the Internet at www.albertarifle.com.

British Columbia Rifle Association. The British Columbia Rifle Association (BCRA) was created in 1874, incorporated in 1910, and is one of the oldest members of the British Columbia Societies Act. The objectives of the BCRA are:

- to create a public sentiment for the encouragement of small arms shooting as a sport; and
- the control and safe handling of firearms and as a necessary part of national defence.

Through the Department of National Defence, members are permitted to participate in shooting events held on military rifle ranges in British Columbia.

The BCRA can be found on the Internet at www.bcrifle.org.

Manitoba Provincial Rifle Association. The Manitoba Provincial Rifle Association Inc. (MPRA) was created in 1872, for the purpose of encouraging rifle shooting among the militia and citizens of Manitoba. The objectives of the MPRA are:

- to enhance the perception of shooting as a sport by encouraging and supporting all athletes involved in shooting to achieve their maximum performance levels; and
- to promote safe firearms handling.



The Honourable D.A. Smith (Lord Strathcona) was a patron of the MPRA for 40 years. He took an interest in shooting and donated many prizes, especially to cadets.

The MPRA can be found on the Internet at www.manitobarifle.ca.

Newfoundland Provincial Rifle Association. The Newfoundland Provincial Rifle Association can be contacted through the Dominion of Canada Rifle Association (DCRA).

Nova Scotia Rifle Association. The Nova Scotia Rifle Association (NSRA) was created in 1861, and is the oldest provincial rifle association. The objectives of the NSRA are:

- to foster the safe and responsible use of firearms, and
- to develop marksmanship skills.

The NSRA can be found on the Internet at www.nsrifle.org.

Ontario Provincial Rifle Association. The Ontario Provincial Rifle Association (ORA) was created in 1868. The objectives of the ORA are:

- to provide opportunities for shooting with different types of rifles; and
- offer programs for marksman from beginner to world class.

The ORA can be found on the Internet at www.ontariorifleassociation.org.

Prince Edward Island Rifle Association. The Prince Edward Island Rifle Association can be contacted through the DCRA.

Province of Quebec Rifle Association. The Province of Quebec Rifle Association (PQRA) was created in 1869 and supports various shooting clubs and associations. The objective of the PQRA is to teach and promote marksmanship in competitive and recreational environments, where safety is first and foremost.

The PQRA can be found on the Internet at www.pqra.org.

Royal New Brunswick Rifle Association. The Royal New Brunswick Rifle Association (RNBRA) was created in 1866 to serve all shooting and related disciplines in New Brunswick. The objectives of the RNBRA are to promote:

- good sportsmanship,
- safe, efficient and practical arms handling, and
- good marksmanship by civilians, civic police and the military.

The RNBRA can be found on the Internet at www.rnbra.ca.

Saskatchewan Provincial Rifle Association. The Saskatchewan Provincial Rifle Association (SPRA) is the governing body for fullbore target rifle shooting in Saskatchewan. The objectives of the SPRA are to promote:

- the pursuit of excellence in marksmanship; and
- the safe and responsible handling of firearms.

The SPRA can be found on the Internet at www.saskrifle.ca.

CONFIRMATION OF TEACHING POINT 2

QUESTIONS

- Q1. What is the objective of provincial rifle associations?
- Q2. How do these rifle associations meet this objective?
- Q3. How do these associations support the cadet movement?

ANTICIPATED ANSWERS

- A1. To promote marksmanship within the province.
- A2. By organizing marksmanship events and competitions.
- A3. By providing competitions for cadet units within their province.

Teaching Point 3**Discuss National Marksmanship Organizations**

Time: 5 min

Method: Interactive Lecture

NATIONAL MARKSMANSHIP ORGANIZATIONS**The DCRA**

The DCRA, headquartered at Connaught Ranges Primary Training Centre, Ottawa, Ont., is Canada's national governing body for fullbore and smallbore target shooting. The DCRA was founded in 1868 and incorporated by parliament in 1890, to encourage marksmanship training in response to the departure of the British military and the Fenian Raids in 1866.

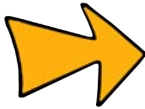

The Fenian Raids were attacks on British targets in Canada between 1866 and 1871, to pressure Britain to withdraw from Ireland. Most of the raids were successfully repelled by British forces and local militias.

The DCRA continues to promote excellence in civilian and military marksmanship.

The DCRA works with the CCM by organizing events and competitions including postal championships held for cadet units across the country and summer matches for the National Rifle Team (NRT) and Canadian and British army cadets on CSTC courses at Connaught NACSTC.

The DCRA can be found on the internet at www.dkra.ca.



Section One of the DCRA postal championships are matches that are restricted to sea, army and air cadets. Section Two is open to any junior team and cadets are encouraged to enter.

The Shooting Federation of Canada (SFC)

The SFC, headquartered at Connaught Ranges Primary Training Centre, Ottawa, Ont., is Canada's national sport governing body for recreational and competitive target shooting in Canada. The SFC is the authority for the marksmanship technical training portion of the National Coaching Certification Program (NCCP).

The SFC can be found on the internet at www.sfc-ftc.ca.

CONFIRMATION OF TEACHING POINT 3**QUESTIONS**

- Q1. What are the two National Marksmanship Organizations in Canada?
- Q2. How does the DCRA work with the NRT?
- Q3. How does the DCRA work with cadet units across Canada?

ANTICIPATED ANSWERS

- A1. The Dominion of Canada Rifle Association and the Shooting Federation of Canada.
- A2. The DCRA works with the NRT by organizing events and competitions during the summer.
- A3. The DCRA conducts postal matches held for cadet units across the country.

Teaching Point 4**Identify the Applicable National/Provincial Biathlon Organizations**

Time: 5 min

Method: Interactive Lecture

BIATHLON CANADA

Biathlon Canada is the governing body for the sport of biathlon within Canada. Biathlon Canada organizes many events, competitions and programs, including the Biathlon Bears Program, which is a community program, offered across Canada. The Biathlon Bears program is open to novices and the training is tailored to the athlete's skill level. This program offers training to develop both skiing and marksmanship skills. As skills are learned and mastered, the biathlete progresses to the next Biathlon Bear level.

PROVINCIAL AND TERRITORIAL BIATHLON ORGANIZATIONS

Divisions of Biathlon Canada are located within many of the provinces and territories. These division offices run training and offer support to the local resorts/clubs. These divisions include:

- Biathlon Alberta,
- Biathlon British Columbia,
- Biathlon Manitoba,
- Biathlon New Brunswick,
- Biathlon Nova Scotia,
- Biathlon Newfoundland and Labrador,
- Biathlon Ontario,
- Biathlon Quebec,
- Biathlon Saskatchewan,
- Biathlon Yukon, and
- Northwest Territories Biathlon.

CONFIRMATION OF TEACHING POINT 4

QUESTIONS

- Q1. What organization is the governing body for the sport of biathlon within Canada?
- Q2. What community biathlon program is offered across Canada?
- Q3. What are the objectives of the provincial and territorial organizations?

ANTICIPATED ANSWERS

- A1. Biathlon Canada is the governing body within Canada.
- A2. Biathlon Bears is offered across Canada.
- A3. To run training and offer support to the local resorts/clubs.

END OF LESSON CONFIRMATION

QUESTIONS

- Q1. What are the Canadian national marksmanship organizations?
- Q2. What marksmanship organizations are in your province/territory?
- Q3. Which of these organizations is your cadet corps active with?

ANTICIPATED ANSWERS

- A1. The DCRA, SFC and Biathlon Canada.
- A2. Answers will vary by province/territory.
- A3. Answers will depend on cadet corps.

CONCLUSION

HOMEWORK/READING/PRACTICE

N/A.

METHOD OF EVALUATION

N/A.

CLOSING STATEMENT

Identifying opportunities with civilian marksmanship organizations, one will know where they can acquire additional marksmanship training that is not supported by the Cadet Program. The opportunities provided by these organizations could enhance one's sense of accomplishment through improved marksmanship skills and allow them to choose activities in which they would like to participate.

INSTRUCTOR NOTES/REMARKS

Have the cadets identify only the applicable national, provincial and local marksmanship organizations.

REFERENCES

- A0-119 Shooting Federation of Canada. (2007). *Shooting Federation of Canada*. Retrieved November 2, 2007, from www.sfc-ftc.ca/document.cfm?sectionID=39.
- C0-149 Biathlon Canada. (2005). *Biathlon Bears: Community Coaching*. Ottawa, ON: Biathlon Canada.
- C2-086 Dominion of Canada Rifle Association. (2007). *History*. Retrieved October 4, 2007, from www.dkra.ca/history.htm.

THIS PAGE INTENTIONALLY LEFT BLANK



COMMON TRAINING
SILVER STAR
INSTRUCTIONAL GUIDE



SECTION 3

EO C306.02 – CORRECT MARKSMANSHIP ERROR

Total Time:

60 min

PREPARATION

PRE-LESSON INSTRUCTIONS

Resources needed for the delivery of this lesson are listed in the lesson specification located in A-CR-CCP-703/PG-001, Chapter 4. Specific uses for said resources are identified throughout the instructional guide within the TP for which they are required.

Review the lesson content and become familiar with the material prior to delivering the lesson.

Photocopy Annexes K and L for each cadet.

Photocopy the answer key located at Annex M for the instructor and assistant instructors.

Set up a mock firing point.

PRE-LESSON ASSIGNMENT

N/A.

APPROACH

An interactive lecture was chosen for TPs 1–3 to give an overview of the theories and the practice of adjusting sights.

A practical activity was chosen for TP 4 as it is an interactive way to introduce and allow cadets to experience adjusting sights on the cadet air rifle in a controlled environment. This activity contributes to the development of sight adjustment skills and knowledge in a fun and challenging setting.

INTRODUCTION

REVIEW

N/A.

OBJECTIVES

By the end of this lesson the cadet is expected to correct marksmanship error by adjusting elevation and windage on the cadet air rifle.

IMPORTANCE

It is important for the cadets to learn how to correct marksmanship error in order to zero the cadet air rifle when participating in a marksmanship activity. A zeroed rifle will give the marksman the assurance that the centre of the target is properly aligned with themselves and their rifle. Having a zeroed rifle and knowing how to zero a rifle is important to every marksman in order to achieve a higher score in application activities.

Teaching Point 1

Explain Centring the Group

Time: 10 min

Method: Interactive Lecture

THE THEORY OF A GROUP

When a series of three or more shots are fired from the same point of aim, they will seldom pass through the same point on the target. The pattern that is produced from the shot holes in the target is called a group.

Factors Affecting the Group

There are three factors that affect the shape and size of the group:

- **The Ammunition.** Even though every pellet is manufactured to be exactly the same, slight variations in each pellet will result in slight variations in results when firing. The number of pellets used will also affect the group size.
- **The Rifle.** Each rifle will fire a pellet with its own slight variation due to small differences in the barrel and firing mechanisms.
- **The Marksman.** Factors associated with the marksman's aiming, holding, breathing and follow-through techniques will affect each shot.

MEAN POINT OF IMPACT (MPI)



Ensure the handout located at Annex K is passed out to the cadets during this portion of the lesson to allow the cadets to see how the MPI moves as more pellets are shot into the target.

The MPI is the point on the target which is the average centre between all shots on the target. As each shot is fired, the MPI changes as the group develops. To centre the group correctly, corrections should be based on the MPI.

To determine the MPI, each shot must be evaluated. It takes at least two shots for an MPI to be determined. For two shots, the MPI will be the point centred between the two shots. After firing three shots, the MPI will change so that the MPI is centred between all three shots (as illustrated in Figure 6-3-1).

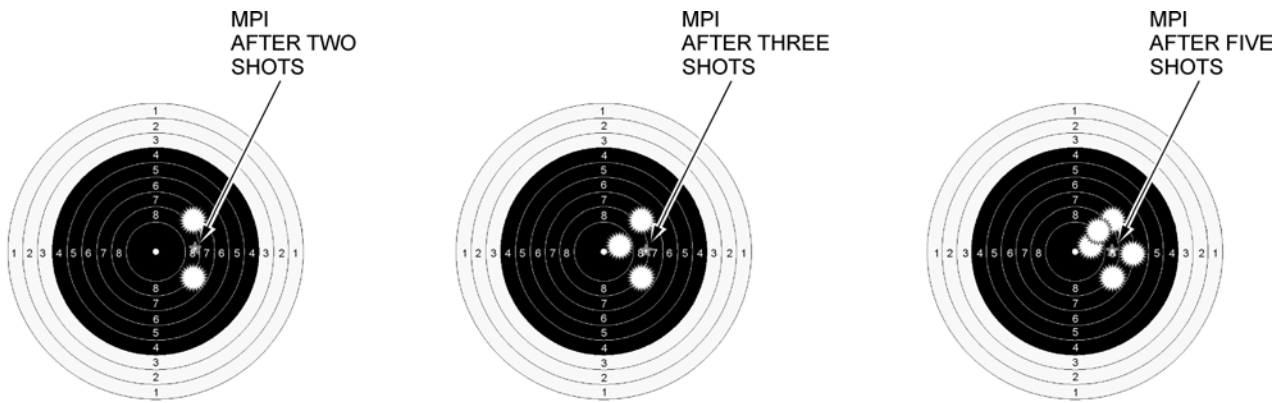

Director Cadets 3, 2007, Ottawa, ON: Department of National Defence

Figure 6-3-1 MPI Examples

CONFIRMATION OF TEACHING POINT 1

QUESTIONS

- Q1. Define the term group.
- Q2. What are the three factors that affect the size and shape of the group?
- Q3. What is the definition of MPI?

ANTICIPATED ANSWERS

- A1. The pattern that is produced from the shot holes in a target.
- A2. The three factors that affect the shape and size of the group:
 - the ammunition,
 - the rifle, and
 - the marksman.
- A3. The MPI is the point on the target which is the average centre between all shots on the target.

Teaching Point 2

Explain Sight Adjustment

Time: 10 min

Method: Interactive Lecture

THE PURPOSE OF SIGHT ADJUSTMENT

Sight adjustment is used to ensure that the rifle is zeroed to the marksman. Sight adjustment will not make up for poor marksmanship skills, but may aid the proficient marksman in aligning their grouping to a target. There are two different ways a sight can be adjusted in order to zero the rifle: the windage and the elevation.

ELEVATION

Elevation affects the pellet by moving its vertical position, which moves the point of impact up or down the target. It compensates for the trajectory drop of the pellet.

WINDAGE

Windage affects the pellet by moving its horizontal position, which moves the point of impact left or right. It compensates for the direction and force of the wind on the pellet.

A ZEROED CADET AIR RIFLE

A zeroed cadet air rifle is accurate for a particular marksman at a particular position and distance from the target. A zeroed cadet air rifle has a particular sight setting that will be perfectly aimed, by putting pellets directly into the centre of the target.

CONFIRMATION OF TEACHING POINT 2

QUESTIONS

- Q1. What is the purpose of adjusting the sights on a rifle?
- Q2. What does the elevation adjustment refer to?
- Q3. What does the windage adjustment refer to?

ANTICIPATED ANSWERS

- A1. Sight adjustment is used to ensure the rifle is zeroed to the marksman.
- A2. Elevation adjustment refers to the adjustment required to compensate for the trajectory drop of the pellet.
- A3. Windage adjustment refers to the adjustment required to compensate for the direction and force of the wind on the pellet.

Teaching Point 3

Explain the Increments of Sight Adjustment

Time: 5 min

Method: Interactive Lecture



Ensure the cadets have a cadet air rifle in front of them during this portion of the lesson in order to see the actual sight of the cadet air rifle and the means in which it functions.

SIGHT ADJUSTMENT OF THE CADET AIR RIFLE

Sight adjustment of the cadet air rifle is achieved by turning the knobs of the rear sight. The elevation adjustment knob is found on the top of the rear sight and the windage elevation knob is found on the right-hand side of the rear sight. They are used to move the MPI of the shot either left or right and up or down. The adjustment of these knobs is measured in clicks that can be felt as the knob is turned. It takes three clicks to move the point of impact approximately one pellet width in any direction.



At a distance of 10 m, each click equals approximately a 1.219 mm shift of the MPI.

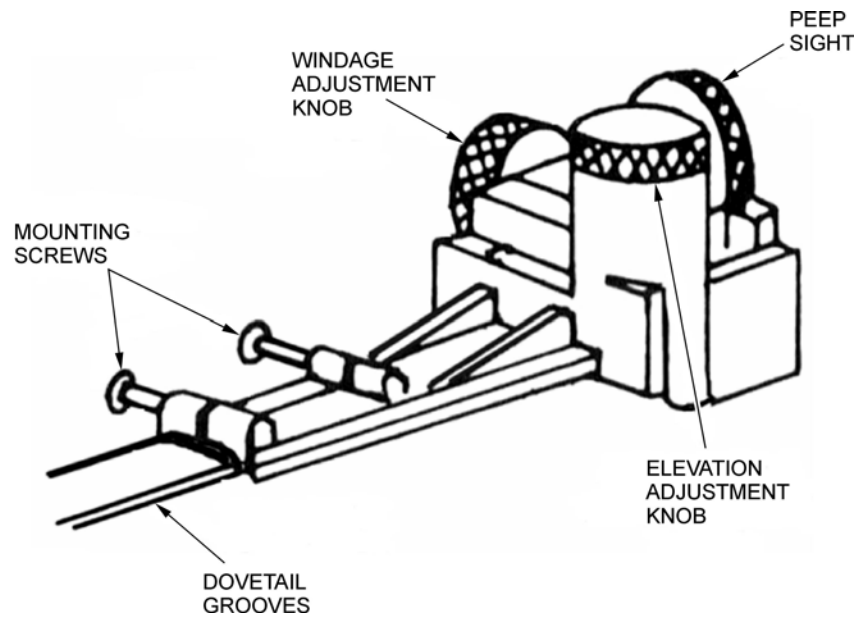

Rogers, AR., AVANTI Competition Pellet Rifle: Operation Manual: AVANTI Legend Model 853, Daisy Outdoor Products (p. 6)

Figure 6-3-2 Rear Sight of the Cadet Air Rifle

LOWERING AND RAISING THE ELEVATION

To lower the elevation of the MPI, turn the elevation knob counter-clockwise (to the left). To raise the elevation of the MPI, turn the elevation knob clockwise (to the right), as per the arrow and the word "UP" located on the knob.

MOVING THE WINDAGE LEFT AND RIGHT

To move the MPI left, turn the windage knob counter-clockwise (to the left). To move the MPI to the right, turn the windage knob clockwise (to the right), as per the arrow and the letter "R" located on the knob.



In order to move the MPI up and to the right turn the elevation and windage knobs clockwise.
In order to move the MPI down and left turn the elevation and windage knobs counter-clockwise.

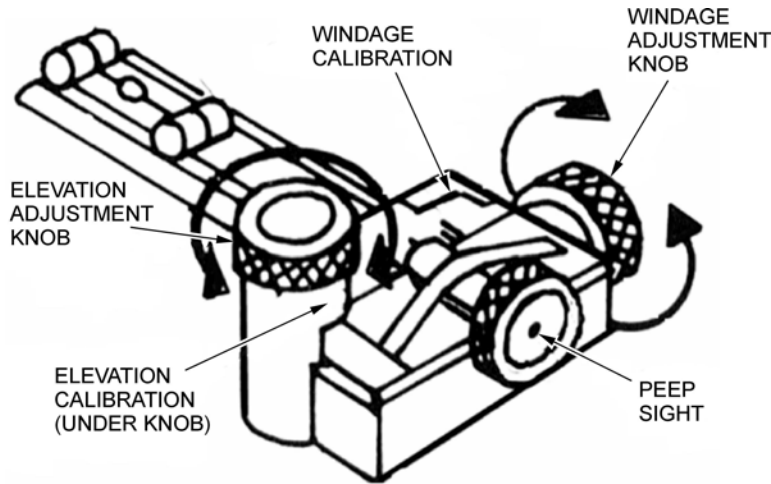

Rogers, AR., AVANTI Competition Pellet Rifle: Operation Manual: AVANTI Legend Model 853, Daisy Outdoor Products (p. 6)

Figure 6-3-3 Sight Adjustment of the Cadet Air Rifle

CONFIRMATION OF TEACHING POINT 3

QUESTIONS

- Q1. How many clicks on the adjustment knob will move the MPI on the target one pellet width in any direction?
- Q2. What direction does the marksman turn the elevation adjustment knob in order to raise the MPI?
- Q3. What direction does the marksman turn the windage adjustment knob in order to move the MPI to the left?

ANTICIPATED ANSWERS

- A1. In order to move the MPI on the target one pellet width, three clicks are required.
- A2. The marksman turns the elevation adjustment knob clockwise (to the right) in order to raise the MPI.
- A3. The marksman turns the windage adjustment knob counter-clockwise (to the left) in order to move the MPI to the left.

Teaching Point 4

Conduct a Sight Adjustment Exercise

Time: 30 min

Method: Practical Activity



Each pair of cadets will complete the exercise located at Annex L and then practice adjusting their sights.

An assistant instructor may be used to aid the cadets in the completion of this activity.

ACTIVITY

OBJECTIVE

The objective of this activity is to confirm that each cadet can determine the MPI and adjust sights accordingly on the cadet air rifle.

RESOURCES

- Cadet air rifle (one per firing lane),
- Sight adjustment activity targets located at Annex L, and
- Pencil/pen.

ACTIVITY LAYOUT

A mock firing point.

ACTIVITY INSTRUCTIONS

1. Divide the cadets into pairs.
2. Distribute the exercise located at Annex L to each cadet.
3. Have the cadets, in pairs, determine the MPI of all five shots for each scoring diagram.
4. Have the cadets put an asterisk to indicate the MPI.
5. Have the cadets determine the vertical and horizontal distance, in clicks, that the MPI must move to be aimed at the centre of the target.
6. Have the cadets write the number of clicks required for the windage and elevation, marking whether to turn the knob clockwise (cw) or counter-clockwise (ccw).
7. Have the cadets practice adjusting the sights on the cadet air rifle for each scoring diagram.
8. Correct using the answer key located at Annex M.

SAFETY

Ensure the following:

- the cadet air rifles are safe by performing individual safety precautions IAW A-CR-CCP-177/PT-001;
- all cadet air rifles are pointed in a safe direction throughout the lesson;
- no pellets or cleaning pellets are present in the training area; and
- all other applicable safety regulations are followed IAW local range standing orders.

CONFIRMATION OF TEACHING POINT 4

The cadets' participation in the activity will serve as the confirmation of this TP.

END OF LESSON CONFIRMATION

The cadets' participation in the sight adjustment exercise will serve as the confirmation of this lesson.

CONCLUSION

HOMEWORK/READING/PRACTICE

N/A.

METHOD OF EVALUATION

N/A.

CLOSING STATEMENT

Correcting marksmanship error is necessary to achieve success in marksmanship activities. It ensures that the marksman, the rifle and the target are aligned and that the centre of aim is in the centre of the target. It is important for each marksman to understand how to adjust their sights in order to achieve a completely aligned rifle.

INSTRUCTOR NOTES/REMARKS

N/A.

REFERENCES

- A0-027 A-CR-CCP-177/PT-001 Director Cadets 3. (2001). *Canadian Cadet Movement: Cadet Marksmanship Program Reference Manual*. Ottawa, ON: Department of National Defence.
- C2-097 Ontario Rifle Association. (2003). *Ontario Rifle Association Handbook for New Member*. Haliburton County, ON: MilCun Marksmanship Complex.
- C2-098 (ISBN 1-931220-05-0) Constantine, R. (1998). *Modern Highpower Competition: From Beginner to Master*. Manchester, CT: Precision Shooting Inc.



COMMON TRAINING
SILVER STAR
INSTRUCTIONAL GUIDE



SECTION 4

EO C306.03 – ADOPT THE STANDING POSITION WITH THE CADET AIR RIFLE

Total Time:

60 min

PREPARATION

PRE-LESSON INSTRUCTIONS

Resources needed for the delivery of this lesson are listed in the lesson specification located in A-CR-CCP-703/PG-001, Chapter 4. Specific uses for said resources are identified throughout the instructional guide within the TP for which they are required.

Review the lesson content and become familiar with the material prior to delivering the lesson.

PRE-LESSON ASSIGNMENT

N/A.

APPROACH

An interactive lecture was chosen for TP 1 to give an overview of the objectives of the standing position.

Demonstration was chosen for TPs 2–4 as it allows the instructor to explain and demonstrate aspects of the standing position.

A practical activity was chosen for TP 5 as it is an interactive way to allow the cadet to experience the standing position in a safe and controlled environment. This activity contributes to the development of marksmanship skills and knowledge in a fun and challenging setting.

INTRODUCTION

REVIEW

N/A.

OBJECTIVES

By the end of this lesson the cadet shall be expected to adopt the standing position with the cadet air rifle.

IMPORTANCE

It is important for cadets to adopt the standing position with the cadet air rifle as this position is used in both biathlon and civilian air rifle competitions. As the standing position is the only position for the international air rifle competitions, it is seen as a progression for cadet recreational marksmanship.

Teaching Point 1**Explain the Objectives of the Standing Position**

Time: 5 min

Method: Interactive Lecture

The first principle of marksmanship is to find a comfortable firing position. The standing position is the easiest and quickest position to assume and does not require any artificial support like the sling in the prone position. It is the most difficult position in which to remain steady as it has the smallest area of support and it has a high centre of gravity. Cadets must accept that when firing in the standing position, they may never achieve complete immobility.

OBTAINING A GOOD POSITION

Obtaining a good position is the most important principle of marksmanship; this is especially true when firing in the standing position. A good position helps to maintain balance, comfort and stability during firing. Cadets should wear comfortable flat sole shoes or boots to add stability to the position and stand on the firmest surface possible. Although an excellent position will not guarantee an excellent performance, a poor position can almost assure a substantially negative effect on one's score.

The objective of a good position is to obtain a stable, balanced, uniform platform in the most efficient way possible allowing holding and aiming to be achieved with as little movement and muscular tension as possible.

The standing position should be:

- natural,
- without strain,
- comfortable,
- stable,
- balanced in such a way that body weight is equally distributed between both feet, and
- consistent throughout the relay.

USING A RIFLE REST

An excellent way for a cadet to learn the standing position is to practice with the use of a rifle rest. Since the movements of the cadet air rifle are amplified from the lack of support points with the standing position, a rifle rest is very helpful. This allows the cadet air rifle to remain steady while allowing the cadet to understand and perfect the marksmanship skills being practiced. Once these skills are learned, the rifle rest should be removed. Some examples of rifle rests for the standing position are a tripod stand, a stool on top of a table or simply a flat surface on the end of a broom stick.

MAINTAINING A CENTRE OF GRAVITY

The instructions given are based on a right-handed marksman. For a left-handed marksman, substitute the left for right and right for left throughout the points.

The centre of gravity is the point where the weight of the rifle and the cadet's body weight are evenly distributed between the feet. In order to compensate for the weight of the rifle, the cadet's back is bent rearward and rotated to the left in order to gain bone support and stability.

If the cadet stands straight, the weight of the cadet air rifle will pull their body to the front. Muscle strain will be felt in the back as the cadet attempts to keep their body from falling forward. By bending backward and rotating the back to the left, a shift in body weight will occur slightly towards the right foot. At a certain point, the weight of the body on the right foot will equal the weight on the left foot. The body-rifle combination then reaches a state of balance, with the centre of gravity located between the cadet's two feet.

CONFIRMATION OF TEACHING POINT 1

QUESTIONS

- Q1. What is the first principle of marksmanship?
- Q2. What is an excellent way for a cadet to learn the standing position?
- Q3. What is the centre of gravity in relation to the standing position?

ANTICIPATED ANSWERS

- A1. Obtaining a good position.
- A2. With the use of a rifle rest.
- A3. The centre of gravity is the point where the weight of the rifle and the cadet's body weight are evenly distributed between the feet.

Teaching Point 2

Explain and Demonstrate Adopting the Standing Position

Time: 5 min

Method: Demonstration



For this TP, it is recommended that instruction take the following format:

1. Explain and demonstrate the complete skill while cadets observe.
2. Explain and demonstrate each step required to complete the skill.

Note: Assistant instructors may be employed to demonstrate the skill as it is explained.



No two bodies are exactly the same, not even twins; therefore, no two bodies will look alike in any shooting position. Building the best position for your performance, means your standing position will differ from the person standing beside you.

ADOPTING THE STANDING POSITION

The following guidelines should be adhered to when adopting the standing position:

1. the body should face to the right, approximately 90 degrees to the target;
2. the feet should be:
 - (a) positioned shoulder width apart,
 - (b) pointed straight ahead in relation to the body, or
 - (c) turned slightly outward for comfort;



The weight of the body and the rifle should be equally distributed between both feet.

3. the legs should be straight with knees unlocked, as locked knees affect circulation, causing increased discomfort and unsteadiness;
4. the hips should be 90 degrees to the target and should not thrust forward;

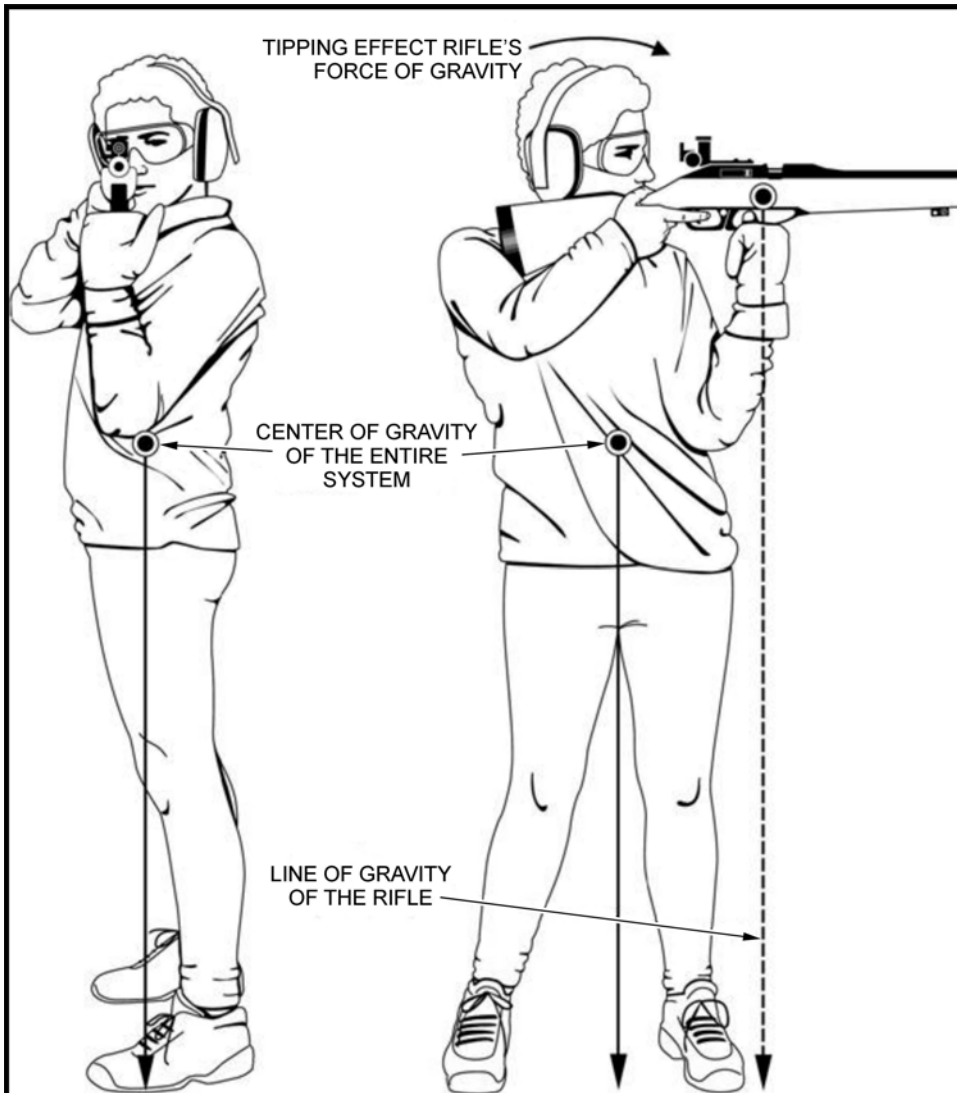

A-CR-CCP-177/PT-001 (p. 2-9)

Figure 6-4-1 Standing Position

5. the back should be bent rearward to gain bone support and stability;
6. the left arm, without muscles used for support, should rest against the ribcage with the elbow almost directly under the rifle, resting against the ribcage or hipbone;
7. the left hand is used to support the rifle and should be positioned on the pump handle, using one of the following methods:
 - (a) forming a clenched fist;



A-CR-CCP-177/PT-001 (p. 1-6-3)

Figure 6-4-2 Clenched Fist

(b) forming a V shape with the thumb and fingers; or



A-CR-CCP-177/PT-001 (p. 1-6-3)

Figure 6-4-3 V Shape With the Thumb and Fingers

(c) using the heel of the hand with relaxed fingers;



A-CR-CCP-177/PT-001 (p. 1-6-4)

Figure 6-4-4 Heel of the Hand

8. the right arm should drop naturally to the side with the right hand placed comfortably, but firmly on the small of the butt;
9. the head should remain in an upright and natural position to allow the eyes to look forward through the sights; and

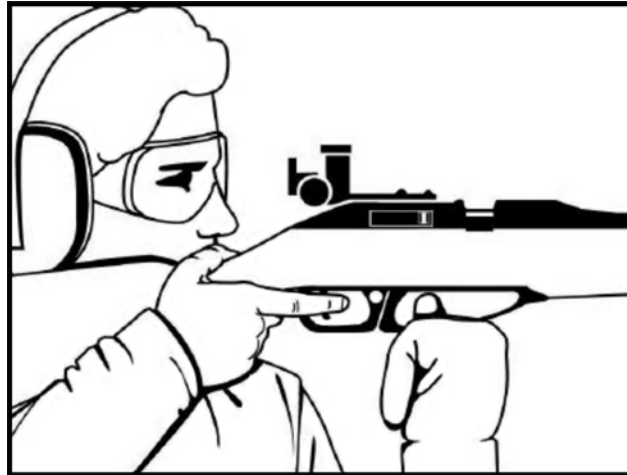

A-CR-CCP-177/PT-001 (p. 1-6-4)

Figure 6-4-5 Head and Eyes

10. the butt should rest slightly high on the shoulder, allowing the cadet air rifle to rest naturally across the chest with the cheek resting on the stock and the sights at eye level.



The standing position allows for a more natural and relaxed position that is more comfortable than prone, as it places less pressure and weight on the spine.

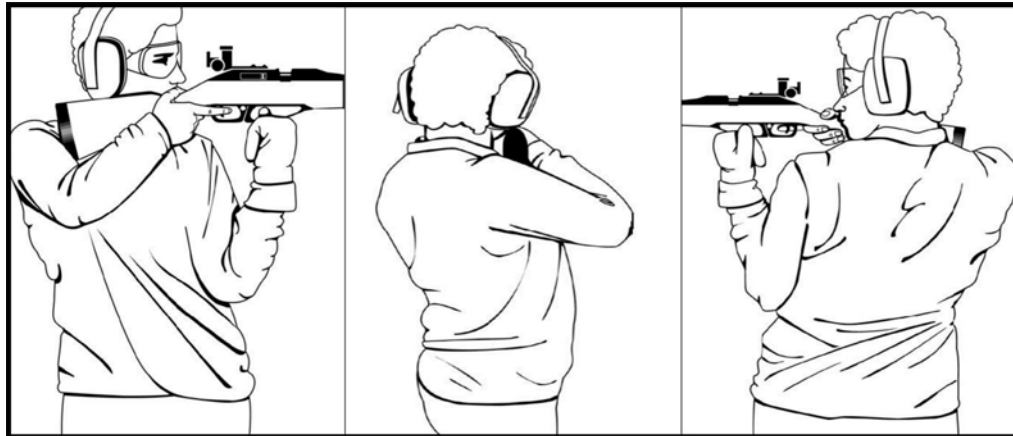

A-CR-CCP-177/PT-001 (p. 2-9)

Figure 6-4-6 Back and Hip Position

CONFIRMATION OF TEACHING POINT 2

QUESTIONS

- Q1. Why is the back bent rearward?
- Q2. Why should the head remain in an upright and natural position?
- Q3. Where should the butt of the cadet air rifle rest?

ANTICIPATED ANSWERS

- A1. The back is bent rearward to gain bone support and stability.
- A2. The head should remain in an upright and natural position to allow the eyes to look forward through the sights.
- A3. The butt resting slightly high on the shoulder, allowing the cadet air rifle to rest naturally across the chest with the cheek resting on the stock and the sights at eye level.

Teaching Point 3

Explain and Demonstrate Adjusting the Aim

Time: 5 min

Method: Demonstration



When firing in the standing position, the larger of the two front apertures should be selected to provide the best sight picture. The aperture size should appear 1-1/2 times bigger than the aiming mark to allow the cadet to see the aiming mark that will be shifting around more than in the prone position.

When aiming the cadet air rifle in the standing position, the aiming process is the same as it is for the prone position. It is achieved by adopting a comfortable position, ensuring body alignment with the target, sight alignment and obtaining a sight picture. The only thing that varies from the prone position is that the front aperture should be larger and eye relief may be longer, but still between 5–15 cm (2–6 inches).



For this TP, it is recommended that instruction take the following format:

1. Explain and demonstrate the complete skill while cadets observe.
2. Explain and demonstrate each step required to complete the skill.

Note: Assistant instructors may be employed to demonstrate the skill as it is explained.

Higher

To adjust the aim higher in the standing position, move the left hand rearward, closer to the trigger guard.

Lower

To adjust the aim lower in the standing position, move the left hand forward, away from the trigger guard.



When smaller adjustments higher or lower are required, they can be achieved by adjusting when to hold a breath during the breathing cycle.

Left and Right

To adjust the aim to the left or right, adjustments are made by moving both feet in such a way as to keep them in the same position in relation to each other. The result should be as if the position was rotated in a disc, turned to the left or right as required.



When smaller adjustments left or right are required, they can be achieved by adjusting the position of the left hand and forearm. Adjusting the aim by this method may result in having to acquire a new firing position.

CONFIRMATION OF TEACHING POINT 3

QUESTIONS

- Q1. How does aiming in the standing position vary from the prone position?
- Q2. How is aiming adjusted higher or lower in the standing position?
- Q3. How is aiming adjusted to the left or right in the standing position?

ANTICIPATED ANSWERS

- A1. The front aperture should be larger and eye relief may be longer, but still between 5–15 cm (2–6 inches).
- A2. By moving the left hand rearward or forward of the trigger guard.
- A3. By moving both feet in such a way as to keep them in the same position in relation to each other, as if on a rotating disc.

Teaching Point 4**Explain and Demonstrate Natural Alignment**

Time: 5 min

Method: Demonstration



Natural alignment is the same procedure for the standing position as it is for the prone position.

Natural alignment describes the direction that the cadet air rifle is aimed when the marksman is in a comfortable standing position with the cadet air rifle at the ready. In a comfortable position, the cadet air rifle should not be forced to point at the target. Even with a comfortable standing position and sight alignment, forcing the cadet air rifle can cause muscle tension and will affect the accuracy of each shot.



For this TP, it is recommended that instruction take the following format:

1. Explain and demonstrate the complete skill while cadets observe.
2. Explain and demonstrate each step required to complete the skill.

Note: Assistant instructors may be employed to demonstrate the skill as it is explained.

Natural alignment is obtained by:

1. adopting the standing position;
2. acquiring a sight picture;
3. closing both eyes;
4. taking 3–4 normal breaths to relax the muscles;
5. after 10 seconds, opening the eyes to inspect the sight picture; and
6. adjusting body position to acquire a sight picture.



The purpose of closing the eyes and relaxing is to allow the muscles to return to a natural position. This allows the position to be adjusted and avoids having to force the cadet air rifle to aim at the target.

CONFIRMATION OF TEACHING POINT 4

QUESTIONS

- Q1. Natural alignment has a marksman in what type of position?
- Q2. How long are the eyes closed, and how many breaths are taken to obtain natural alignment?
- Q3. What negative effect can forcing the cadet air rifle have?

ANTICIPATED ANSWERS

- A1. In a comfortable standing position with the cadet air rifle at the ready.

A2. The eyes are closed for 10 seconds and 3–4 natural breaths are taken.

A3. It can cause muscle tension and will affect the accuracy of each shot.

Teaching Point 5**Have the Cadets Adopt the Standing Position**

Time: 30 min

Method: Practical Activity

ACTIVITY

OBJECTIVE

The objective of this activity is to have cadets adopt the standing position, position the cadet air rifle into the shoulder, obtain natural alignment and adjust their position as required.

RESOURCES

- Cadet air rifle (one per firing lane),
- Rifle rest (one per firing lane),
- Target frame (one per firing lane),
- Suitable target (one per firing lane),
- Raised target platform (one per firing lane),
- Safety glasses/goggles.

ACTIVITY LAYOUT

Construct an air rifle range IAW Part 1, Section 8 of A-CR-CCP-177/PT-001.

ACTIVITY INSTRUCTIONS

1. Divide cadets into equal relays according to the number of firing lanes.
2. Have the relays take turns assuming the standing position using the cadet air rifle.
3. With assistance, allow the cadets to practice the standing position as taught.
4. Have cadets adjust their standing position, to include:
 - (a) the body should face 90 degrees to the target;
 - (b) the feet should be:
 - (1) positioned shoulder width apart,
 - (2) pointed straight ahead in relation to the body, or
 - (3) turned slightly outward for comfort,
 - (c) the legs should be straight with knees unlocked;
 - (d) the hips should be 90 degrees to the target and not thrust forward;
 - (e) the back should be bent rearward;

- (f) the left arm should rest against the ribcage with the elbow under the rifle, resting against the ribcage or hipbone;
 - (g) the left hand supporting the rifle, should be positioned on the pump handle;
 - (h) the right arm should drop naturally to the side with the right hand placed on the small of the butt;
 - (i) the head should remain upright and in a natural position to allow the eyes to look through the sights; and
 - (j) the butt should rest slightly high on the shoulder, allowing the cadet air rifle to rest naturally across the chest with the cheek resting on the stock and the sights at eye level.
5. Inspect each cadet for a comfortable position.
 6. Repeat steps as required, within the allotted time.

SAFETY

Ensure that the cadet air rifles are pointed in a safe direction at all times. Cadets will treat air rifles as though they are loaded.

CONFIRMATION OF TEACHING POINT 5

The cadets' participation in the standing position activity will serve as the confirmation of this TP.

END OF LESSON CONFIRMATION

The cadets' participation in the activity in TP 5 will serve as the confirmation of this lesson.

CONCLUSION

HOMEWORK/READING/PRACTICE

N/A.

METHOD OF EVALUATION

N/A.

CLOSING STATEMENT

The standing position is the least stable position due to its high centre of gravity and small support area. It requires a great amount of concentration and practice. The standing position is seen as a progression for cadet recreational marksmanship and is the only position for the international air rifle competitions.

INSTRUCTOR NOTES/REMARKS

Cadets who have completed this lesson will participate in EO M306.01 (Participate in a Recreational Marksmanship Activity, Section 1) from the standing position.

REFERENCES

A0-027 A-CR-CCP-177/PT-001 Director Cadets 3. (2001). *Canadian Cadet Movement: Cadet Marksmanship Program Reference Manual*. Ottawa, ON: Department of National Defence.

C2-146 (ISBN 0-9655780-0-3) Pullum, B. & Hanenkrat, F. (1997). *The New Position Rifle Shooting: A Comprehensive Guide to Better Target Shooting*. Oak Harbor, OH: Target Sports Education Center.

CLASSIFICATION ACTIVITY

| CLASSIFICATION ACTIVITY |
|---|
| <p>Objective. To provide cadets the opportunity to obtain marksmanship classifications.</p> |
| <p>Scoring. The standard for the classification levels that are:</p> <ol style="list-style-type: none">1. Marksman: Two five-round groupings within a circle of 3 cm in diameter.2. First Class Marksman: Two five-round groupings within a circle of 2.5 cm in diameter.3. Expert Marksman: Two five-round groupings within a circle of 2 cm in diameter.4. Distinguished Marksman: Two five-round groupings within a circle of 1.5 cm in diameter. |
| <p>Equipment Required</p> <p>Mandatory:</p> <ul style="list-style-type: none">• CCT200GRTD Canadian Cadet Movement (CCM) Air Rifle Grouping Target (one per cadet),• Air Rifle Grouping Template from A-CR-CCP-177/PT-001 (p. B1-1), and• A stopwatch. <p>Optional aids to firing are limited to the following:</p> <ul style="list-style-type: none">• Cadet air rifle sling,• Marksmanship jacket,• Shooting glove, and• Hat. |
| <p>Activity Instructions</p> <ol style="list-style-type: none">1. Distribute an Air Rifle Grouping Target to each cadet.2. Have the cadets write their name and date on the target and attach it to the target frame.3. Give the cadets five pellets to fire into the centre of the target.4. Have the cadets fire in relays following the commands given by the RSO.5. Give the cadets 15 minutes to complete firing.6. Have the cadets retrieve their targets.7. Score the targets using the Air Rifle Grouping Template.8. Record the scores and allow the cadets to keep their targets. <p>The following is prohibited:</p> <ul style="list-style-type: none">• Alterations made to the rifles.• A pellet-loading clip.• Supports used as a rest for the rifle or the forearm.• A spotting scope.• Use of sights not provided with the cadet air rifle.• Coaching. |

THIS PAGE INTENTIONALLY LEFT BLANK

FUN ACTIVITIES – PYRAMID

| PYRAMID |
|--|
| Objective. To fire pellets into each point on the pyramid. |
| Scoring. One point is awarded for each point on the pyramid that is hit by a pellet. |
| Equipment Required Mandatory: Pyramid Target (one per cadet). Optional aids to firing are limited to the following: <ul style="list-style-type: none">• Cadet air rifle sling,• Marksmanship jacket,• Shooting glove, and• Hat. |
| Activity Instructions <ol style="list-style-type: none">1. Distribute one Pyramid Target to each cadet.2. Have the cadets write their name and date on the target and attach it to the target frame.3. Give the cadets three pellets to fire, one pellet into each corner of the pyramid.4. Have the cadets fire in relays following the commands given by the RSO.5. Give the cadets three minutes to complete firing.6. Score the targets awarding one point for each corner hit on the pyramid.7. Allow the cadets to review and keep their targets. <p>The following actions are prohibited:</p> <ul style="list-style-type: none">• Alterations made to the rifles.• A pellet-loading clip.• Supports used as a rest for the rifle or the forearm.• A spotting scope.• Use of sights not provided with the cadet air rifle. |

PYRAMID TARGET

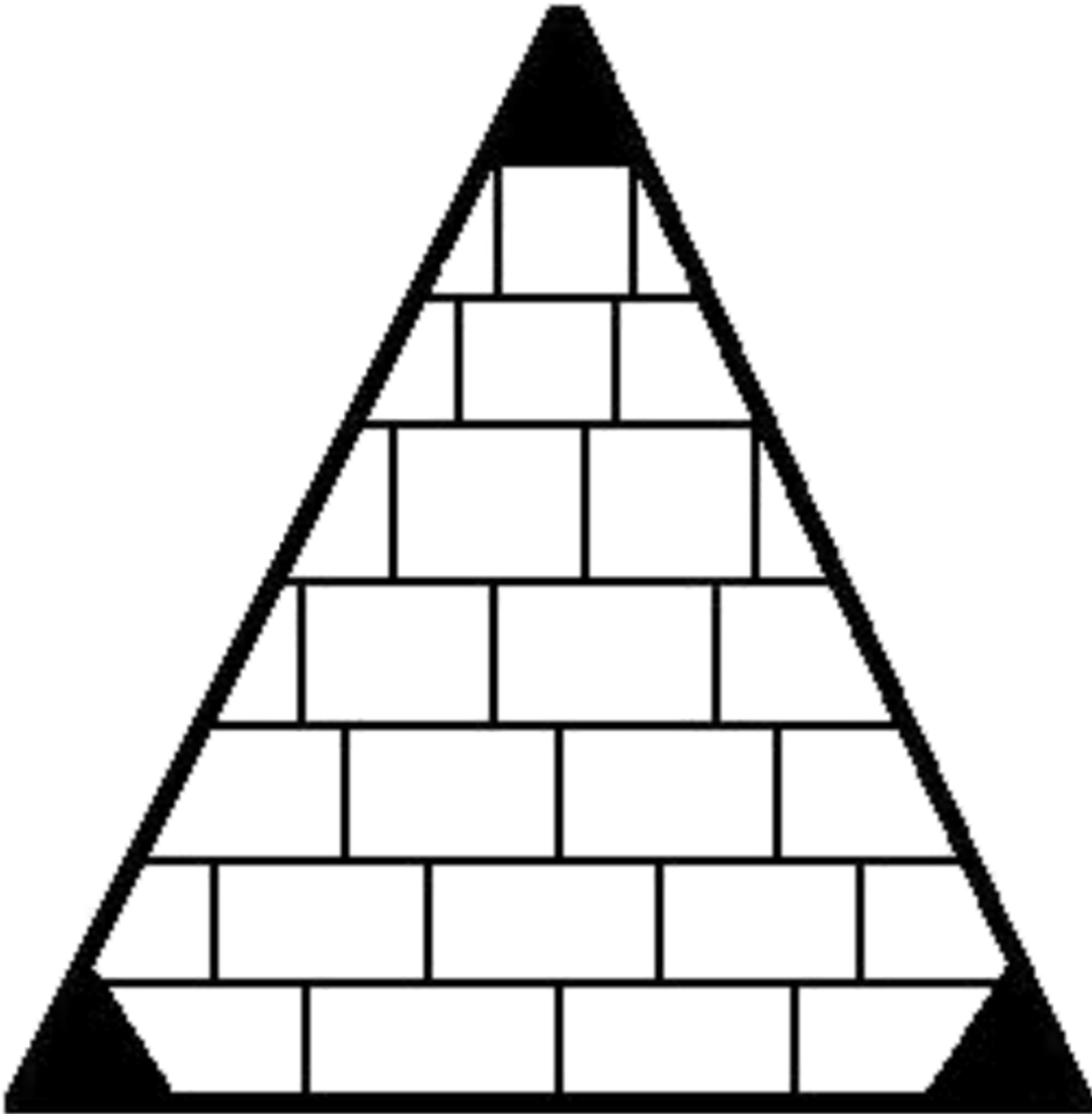

Name: _____ Date: _____

Director Cadets 3, 2007, Ottawa, ON: Department of National Defence

Figure 6B-1 Pyramid Target

FUN ACTIVITIES – SHOOTING STAR

| SHOOTING STAR | |
|------------------------------|--|
| Objective. | To fire a pellet into each point on the star. |
| Scoring. | One point is awarded for each point on the star that is hit by a pellet. |
| Equipment Required | <p>Mandatory: Star Target (one per cadet).</p> <p>Optional aids to firing are limited to the following:</p> <ul style="list-style-type: none">• Cadet air rifle sling,• Marksmanship jacket,• Shooting glove, and• Hat. |
| Activity Instructions | <ol style="list-style-type: none">1. Distribute one Star Target to each cadet.2. Have the cadets write their name and date on the target and attach it to the target frame.3. Give the cadets five pellets to fire, one pellet into each point on the star.4. Have the cadets fire in relays following the commands given by the RSO.5. Give the cadets five minutes to complete firing.6. Score the targets awarding one point for a pellet hit within each point on the star.7. Allow the cadets to review and keep their targets. <p>The following is prohibited:</p> <ul style="list-style-type: none">• Alterations made to the rifles.• A pellet-loading clip.• Supports used as a rest for the rifle or the forearm.• A spotting scope.• Use of sights not provided with the cadet air rifle. |

STAR TARGET

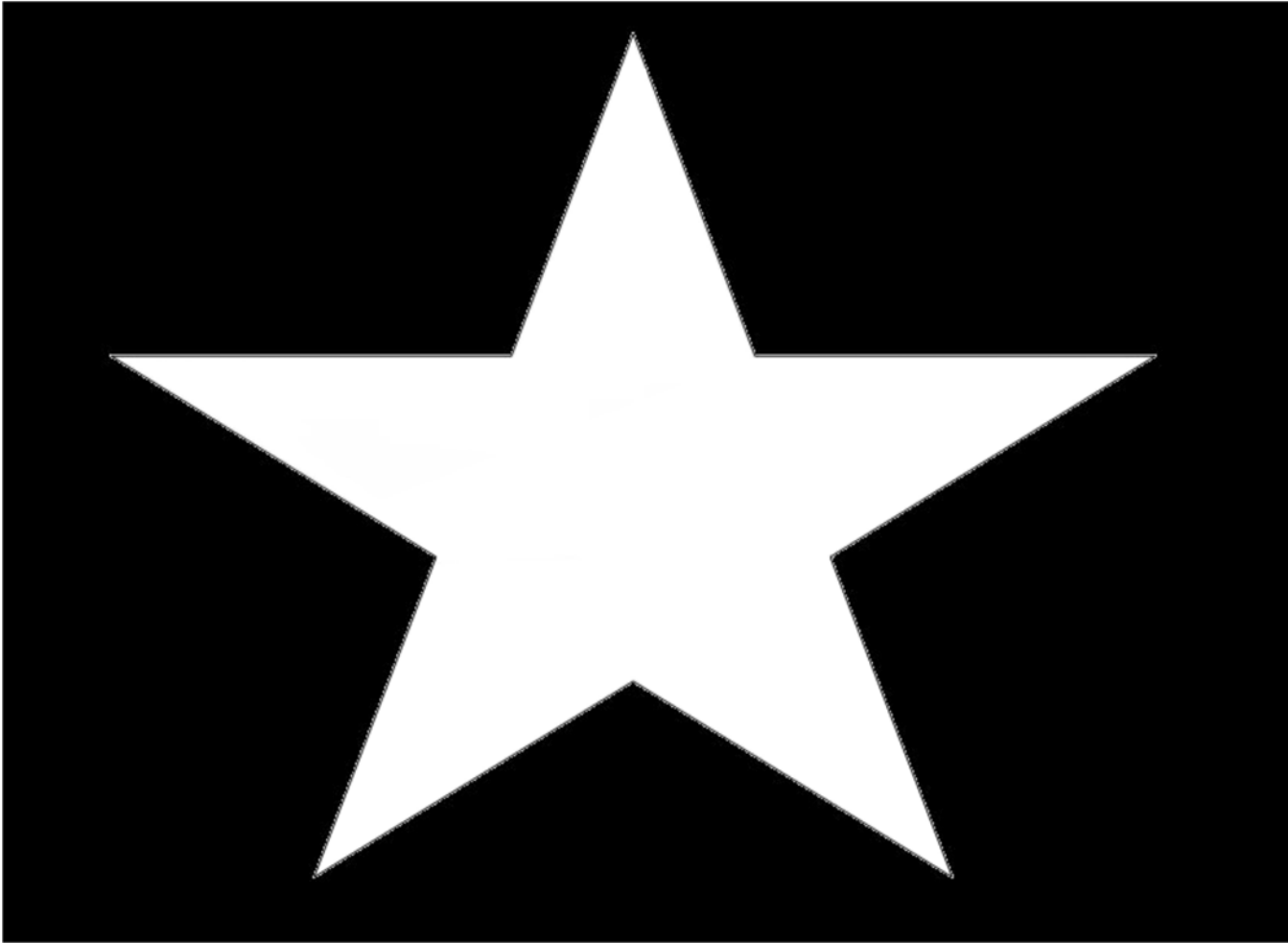

Name: _____ Date: _____

Director Cadets 3, 2007, Ottawa, ON: Department of National Defence

Figure 6C-1 Star Target

FUN ACTIVITIES – BEACH BALL

| BEACH BALL |
|---|
| Objective. To fire 10 pellets into the black circle on the beach ball. |
| Scoring. One point is awarded for each successful hit in the black circle. |
| Equipment Required Mandatory: Beach Ball Target (one per cadet). Optional aids to firing are limited to the following: <ul style="list-style-type: none">• Cadet air rifle sling,• Marksmanship jacket,• Shooting glove, and• Hat. |
| Activity Instructions <ol style="list-style-type: none">1. Distribute one Beach Ball Target to each cadet.2. Have the cadets write their name and date on the target and attach it to the target frame.3. Give the cadets 10 pellets to fire into the black circle of the beach ball.4. Have the cadets fire in relays following the commands given by the RSO.5. Give the cadets 10 minutes to complete firing.6. Score the targets awarding one point for each pellet hit within the black circle.7. Allow the cadets to review and keep their targets. <p>The following is prohibited:</p> <ul style="list-style-type: none">• Alterations made to the rifles.• A pellet-loading clip.• Supports used as a rest for the rifle or the forearm.• A spotting scope.• Use of sights not provided with the cadet air rifle. |

BEACH BALL TARGET



Name: _____ Date: _____

Director Cadets 3, 2006, Ottawa, ON: Department of National Defence

Figure 6D-1 Beach Ball Target

FUN ACTIVITIES – BALLOONS

| BALLOONS |
|--|
| Objective. To fire pellets into balloons on the target. |
| Scoring. One point is awarded for each balloon hit by a pellet. |
| Equipment Required Mandatory: Balloon Target (one per cadet). Optional aids to firing are limited to the following: <ul style="list-style-type: none">• Cadet air rifle sling,• Marksmanship jacket,• Shooting glove, and• Hat. |
| Activity Instructions <ol style="list-style-type: none">1. Distribute one Balloon Target to each cadet.2. Have the cadets write their name and date on the target and attach it to the target frame.3. Give the cadets five pellets to fire, one pellet into each balloon.4. Have the cadets fire in relays following the commands given by the RSO.5. Give the cadets five minutes to complete firing.6. Score the targets awarding one point for each balloon hit.7. Allow the cadets to review and keep their targets. The following is prohibited: <ul style="list-style-type: none">• Alterations made to the rifles.• A pellet-loading clip.• Supports used as a rest for the rifle or the forearm.• A spotting scope.• Use of sights not provided with the cadet air rifle. |
| Note: Actual balloons may be used in place of the paper targets. |

BALLOON TARGET

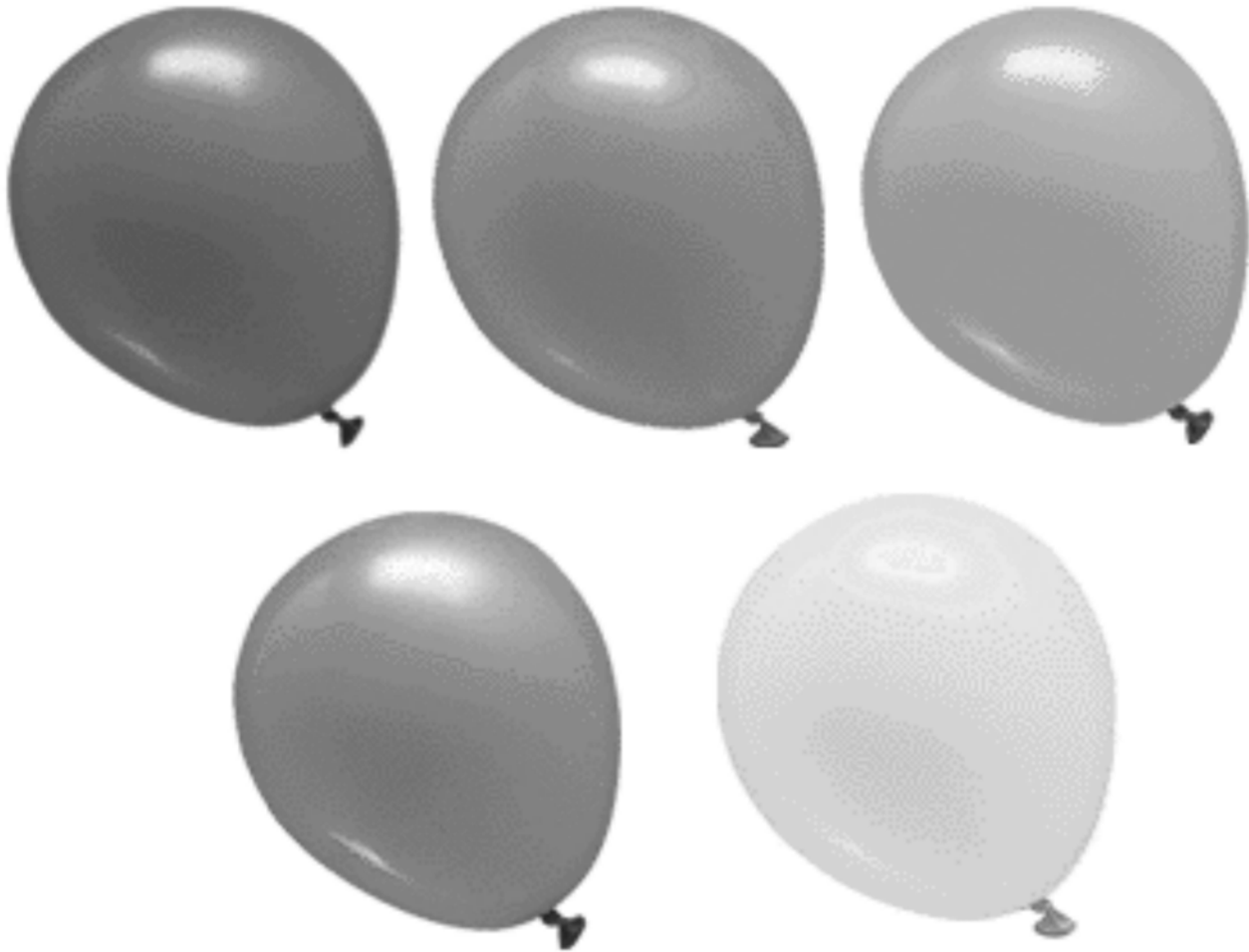

Name: _____ Date: _____

Director Cadets 3, 2007, Ottawa, ON: Department of National Defence

Figure 6E-1 Balloon Target

TIMED ACTIVITIES – CHASE THE DOTS

| CHASE THE DOTS | |
|--|--|
| Objective. | To fire pellets into the dots on the target in a clockwise direction, within a time limit. |
| Scoring. | One point is awarded for each black dot that is hit by a pellet within the time allotted. |
| Equipment Required | |
| Mandatory: | |
| <ul style="list-style-type: none">• Chase the Dots Target (one per cadet), and• A stopwatch. | |
| Optional aids to firing are limited to the following: | |
| <ul style="list-style-type: none">• Cadet air rifle sling,• Marksmanship jacket,• Shooting glove, and• Hat. | |
| Activity Instructions | |
| <ol style="list-style-type: none">1. Distribute one Chase the Dots Target to each cadet.2. Have the cadets write their name and date on the target and attach it to the target frame.3. Give the cadets eight pellets to fire, one pellet into each black dot, in a clockwise direction.4. Have the cadets fire in relays following the commands given by the RSO.5. Give the cadets eight minutes to complete firing.6. Score the targets awarding one point for each black dot hit.7. Allow the cadets to review and keep their targets. | |
| The following is prohibited: | |
| <ul style="list-style-type: none">• Alterations made to the rifles.• A pellet-loading clip.• Supports used as a rest for the rifle or the forearm.• A spotting scope.• Use of sights not provided with the cadet air rifle.• Coaching. | |
| Note: | To make this activity more difficult, shorten the time allowance. |

CHASE THE DOTS TARGET

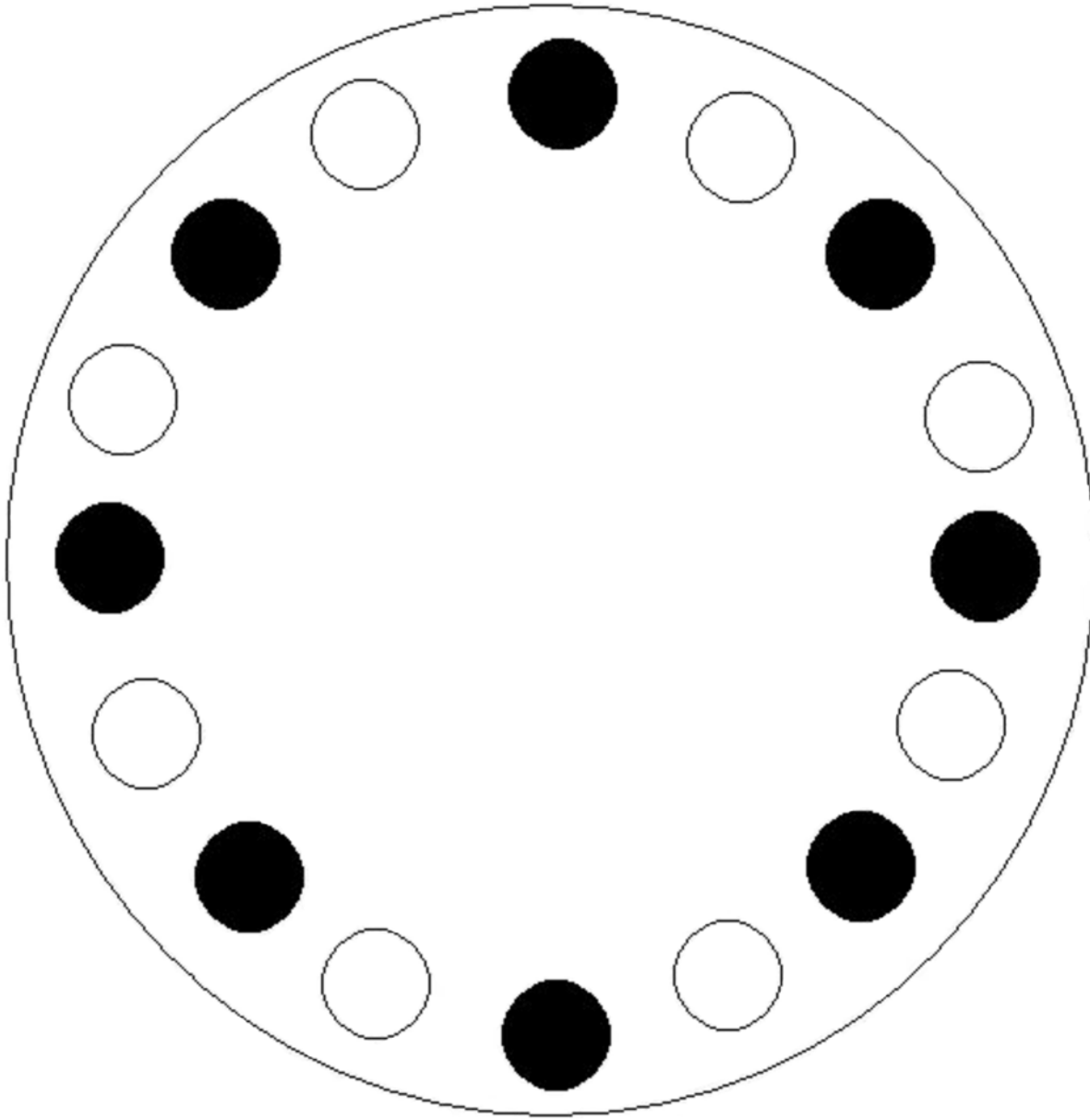

Name: _____ Date: _____

Director Cadets 3, 2007, Ottawa, ON: Department of National Defence

Figure 6F-1 Chase the Dots Target

TIMED ACTIVITIES – SPEED GRID

| SPEED GRID |
|--|
| Objective. To fire pellets into the circles on the target, within a time limit. |
| Scoring. One point is awarded for each circle that is hit by a pellet within the time allotted. |
| Equipment Required Mandatory: <ul style="list-style-type: none">• Cadet air rifle five-pellet clip (three per firing lane),• Speed Grid Target (one per cadet), and• A stopwatch. Optional aids to firing are limited to the following: <ul style="list-style-type: none">• Cadet air rifle sling,• Marksmanship jacket,• Shooting glove, and• Hat. |
| Activity Instructions <ol style="list-style-type: none">1. Distribute one Speed Grid Target to each cadet.2. Have the cadets write their name and date on the target and attach it to the target frame.3. Give the cadets 15 pellets, pre-loaded into three five pellet clips.4. Have the cadets fire one pellet into each circle on the target.5. Have the cadets fire in relays following the commands given by the RSO.6. Give the cadets 15 minutes to complete firing.7. Score the targets awarding one point for each circle hit.8. Allow the cadets to review and keep their targets. The following is prohibited: <ul style="list-style-type: none">• Alterations made to the rifles.• Supports used as a rest for the rifle or the forearm.• A spotting scope.• Use of sights not provided with the cadet air rifle.• Coaching. |
| Note: To make this activity more difficult, shorten the time allowance. |

SPEED GRID TARGET

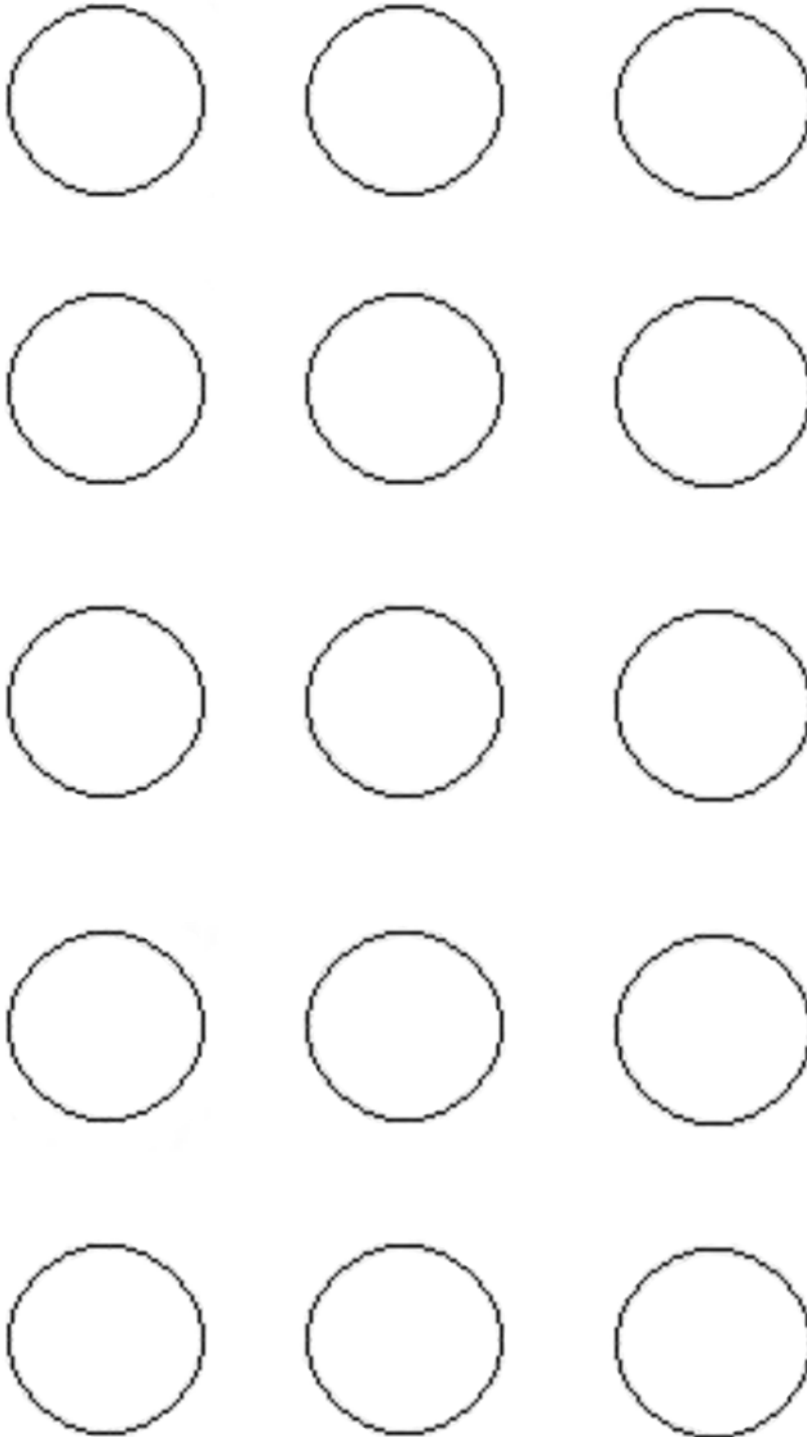

Name: _____ Date: _____

Director Cadets 3, 2007, Ottawa, ON: Department of National Defence

Figure 6G-1 Speed Grid Target

TIMED ACTIVITIES – BEAT THE CLOCK

| BEAT THE CLOCK | |
|---|---|
| Objective. | To fire pellets into the designated hours (numbers) within a time limit. |
| Scoring. | One point is awarded for each correct hour (number) hit by a pellet within the time allotted. |
| Equipment Required | |
| Mandatory: | |
| <ul style="list-style-type: none">• Beat the Clock Target (one per cadet), and• A stopwatch. | |
| Optional aids to firing are limited to the following: | |
| <ul style="list-style-type: none">• Cadet air rifle sling,• Marksmanship jacket,• Shooting glove, and• Hat. | |
| Activity Instructions | |
| <ol style="list-style-type: none">1. Distribute one Beat the Clock Target to each cadet.2. Have the cadets write their name and date on the target and attach it to the target frame.3. Have the cadets fire in relays following the commands given by the RSO.4. Have the RSO using the 12-hour clock, call out one number every 20 second for a total of six numbers.5. Give the cadets six pellets to fire, one pellet at each hour (number) as it is called.6. Score the targets awarding one point for each correct number hit on the target.7. Allow the cadets to review and keep their targets. | |
| The following is prohibited: | |
| <ul style="list-style-type: none">• Alterations made to the rifles.• Supports used as a rest for the rifle or the forearm.• A spotting scope.• Use of sights not provided with the cadet air rifle.• Coaching. | |
| Note: | To make this activity more difficult, shorten the time allowance. |

BEAT THE CLOCK TARGET

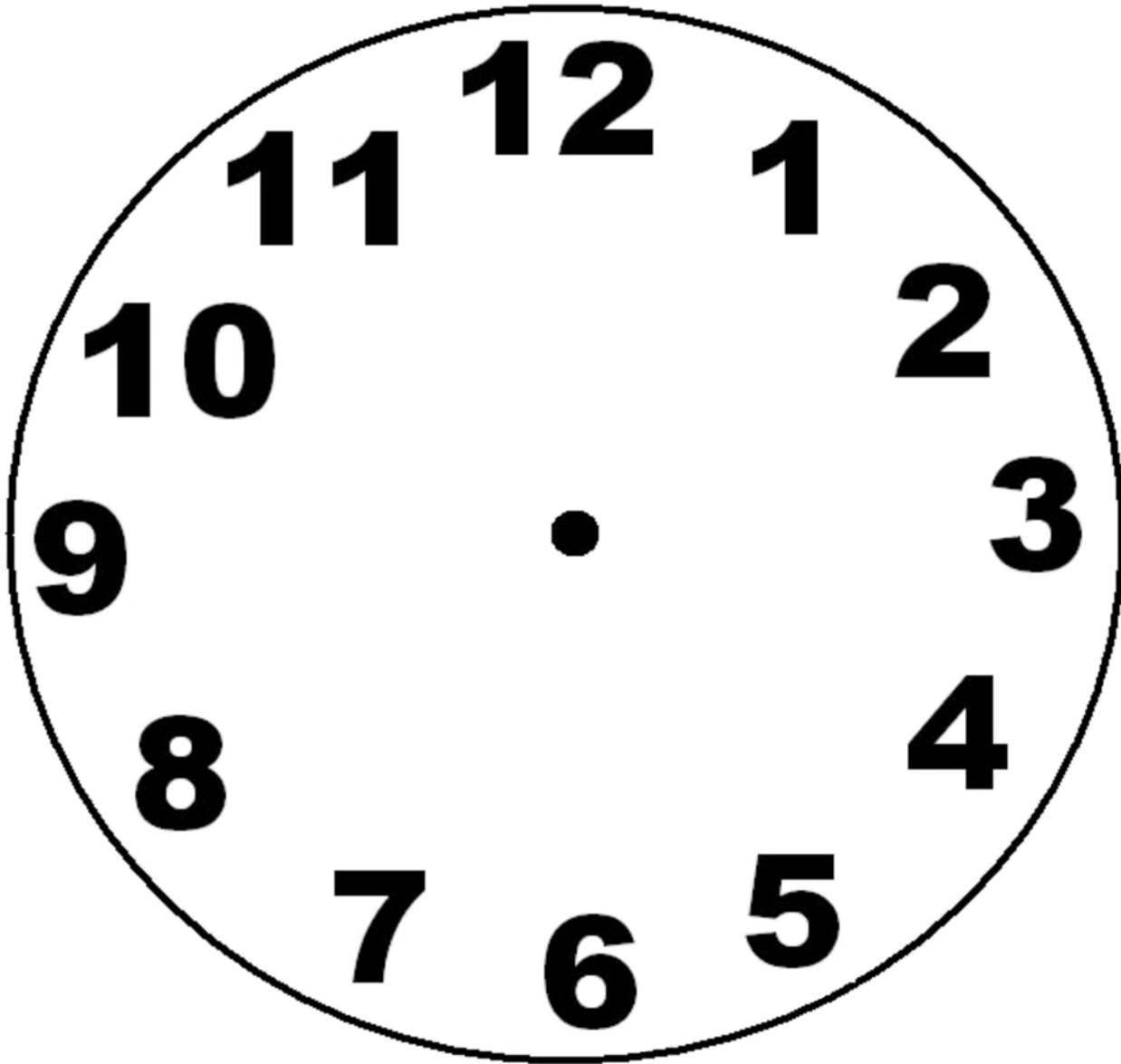

Name: _____ Date: _____

Director Cadets 3, 2007, Ottawa, ON: Department of National Defence

Figure 6H-1 Clock Target

COMPETITIVE ACTIVITIES – CORPS MARKSMANSHIP COMPETITION

| CORPS MARKSMANSHIP COMPETITION |
|---|
| <p>Objective. To provide cadets the opportunity to compete within the corps.</p> |
| <p>Scoring. Targets will be scored IAW A-CR-CCP-177/PT-001, to include:</p> <ul style="list-style-type: none">• Each target has a highest possible score of 100 points (10 diagrams worth 10 points each).• All shot holes are scored using the highest value of the scoring ring that it is broken.• Shots outside the scoring rings are given a value of zero.• If more than the one pellet is fired on a target, the shots with the highest value will be discarded until one shot remain on the target. Also, a two-point penalty will be deducted for each excess shot.• If more than one shot is fired at a scoring diagram, only the prescribed number of shots may be fired at the remaining diagrams [eg, if two shots were fired at the first diagram, one diagram on the target would remain blank (free of shots)]. If this occurs more than twice, a two-point penalty will be deducted for each excess shot.• This activity may be conducted as individuals or teams of four. |
| <p>Equipment Required</p> <p>Mandatory: CCT2001AR853 CCM Competition Targets (two per cadet).</p> <p>Optional aids to firing are limited to the following:</p> <ul style="list-style-type: none">• Cadet air rifle sling,• Marksmanship jacket,• Shooting glove, and• Hat. |
| <p>Activity Instructions</p> <ol style="list-style-type: none">1. Distribute two CCT2001AR853 CCM Competition Targets to each cadet.2. Have the cadets write their name and date on each target and attach them to the target frame.3. Give the cadets 20 scoring pellets to fire, one pellet at each scoring diagram (additional zeroing pellets are permitted).4. Have the cadets fire in relays, following the commands given by the RSO.5. Give the cadets 30 minutes to complete firing.6. Have the RSO collect the targets, score as described above and record the results.7. Allow the cadets to review and keep their targets. <p>The following is prohibited:</p> <ul style="list-style-type: none">• Crossfiring.• Alterations made to the rifles.• Supports used as a rest for the rifle or the forearm.• A spotting scope.• Use of sights not provided with the cadet air rifle. |

THIS PAGE INTENTIONALLY LEFT BLANK

COMPETITIVE ACTIVITIES – LUNAR LAUNCH

| LUNAR LAUNCH | | | |
|---|---------------------|----------------------|---------------------------------------|
| Objective. To provide cadets the opportunity to compete within the corps. | | | |
| Scoring. The average distance from the earth to the moon is 384 400 km. All targets from marksmanship activities conducted during marksmanship training will be added together to calculate a distance from earth and achieve a position on the space shuttle crew. The four scoring levels/positions must meet the following standards: | | | |
| 1. | Mission Commander: | A score of 100 plus: | 384 400 km from earth, lunar landing! |
| 2. | Mission Specialist: | A score of 75 to 99: | 288 300 km from earth. |
| 3. | Chief Engineer: | A score of 50 to 74: | 192 200 km from earth. |
| 4. | Science Officer: | A score of 25 to 49: | 96 100 km from earth, lunar launch! |
| Equipment Required | | | |
| Mandatory: Scores for all targets used in marksmanship activities during the training year. | | | |
| Activity Instructions | | | |
| 1. Add the scores from the targets used by each cadet during the training year. | | | |
| 2. Use the scoring method described above to assign the cadets levels/positions on the space shuttle crew. | | | |
| Notes: | | | |
| 1. A record must be kept of each cadet's scores from all marksmanship activities. | | | |
| 2. This activity may be conducted over multiple training years. | | | |
| 3. The certificate found in this annex may be awarded to cadets who achieve levels/positions in this activity. | | | |



This is to certify that

has achieved the position of

in the



Lunar Launch Marksmanship Activity

Date

Range Safety Officer

MPI EXAMPLES

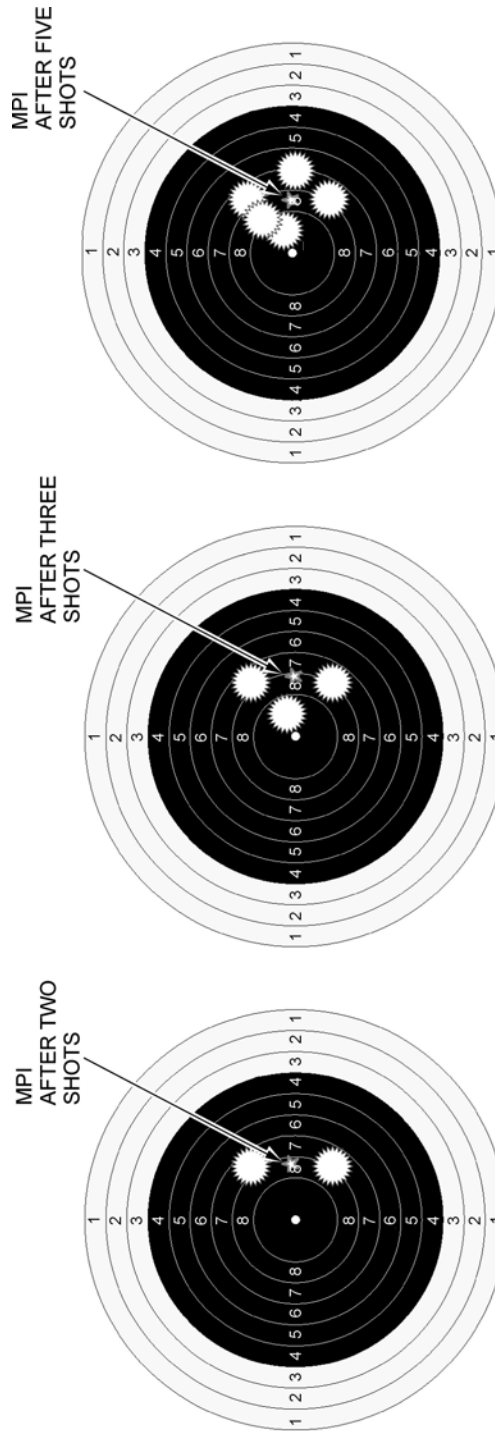

Director Cadets 3, 2007, Ottawa, ON: Department of National Defence

Figure 6K-1 MPI Examples

THIS PAGE INTENTIONALLY LEFT BLANK

SIGHT ADJUSTMENT ACTIVITY

Name: _____ Date: _____



ELEVATION: _____
WINDAGE: _____



ELEVATION: _____
WINDAGE: _____



ELEVATION: _____
WINDAGE: _____



ELEVATION: _____
WINDAGE: _____



ELEVATION: _____
WINDAGE: _____



ELEVATION: _____
WINDAGE: _____



ELEVATION: _____
WINDAGE: _____

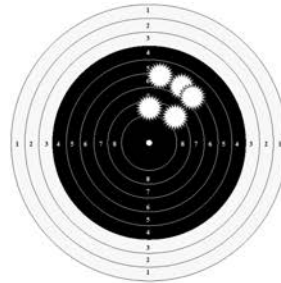

ELEVATION: _____
WINDAGE: _____



ELEVATION: _____
WINDAGE: _____

Director Cadets 3, 2007, Ottawa, ON: Department of National Defence

Figure 6L-1 Sight Adjustment Activity Targets

THIS PAGE INTENTIONALLY LEFT BLANK

SIGHT ADJUSTMENT ACTIVITY ANSWER KEY



ELEVATION: 1 CCW
WINDAGE: 4 CCW



ELEVATION: 2 CCW
WINDAGE: 1 CW



ELEVATION: 5 CW
WINDAGE: 6 CCW



ELEVATION: 6 CW
WINDAGE: NONE



ELEVATION: 9 CW
WINDAGE: 12 CCW

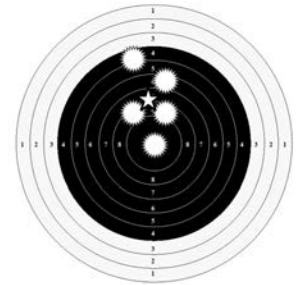

ELEVATION: 6 CCW
WINDAGE: 1 CW



ELEVATION: 1 CCW
WINDAGE: 6 CCW



ELEVATION: 8 CCW
WINDAGE: 4 CCW



ELEVATION: 0 CLICKS
WINDAGE: 0 CLICKS

Director Cadets 3, 2007, Ottawa, ON: Department of National Defence

Figure 6M-1 Answer Key Targets

THIS PAGE INTENTIONALLY LEFT BLANK